



## UHA-6S

### USB DAC and Headphone Amplifier

## User Guide

**Caution:** The UHA-6S amplifier is capable of generating extremely loud signals with most earphones and headphones. Always start with the volume control at minimum, and then increase the volume until a comfortable listening level is achieved. Extended listening at loud volume may cause permanent hearing damage.

### Front Panel

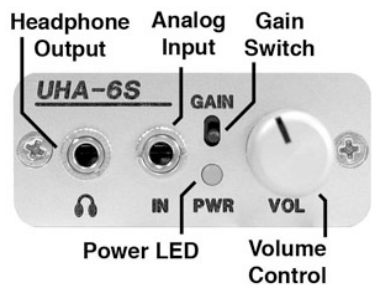

1. **Headphone Output (1/8", 3.5mm)** – Connect to any headphones, earphones, or line level input.
2. **Analog Input (1/8", 3.5mm)** – Connect to any headphone output or line level output.
3. **Gain Switch** – 18 dB maximum gain in high-gain mode (switch in the *up* position), 6 dB maximum gain in low-gain mode (switch in the *down* position).
4. **Power LED** – Blue indicates greater than one hour of battery life remaining. Red indicates less than one hour of battery life remaining.
5. **Volume Control** – Maximum setting (fully clockwise) provides 18 dB gain in high-gain mode, 6 dB gain in low-gain mode.

### Rear Panel

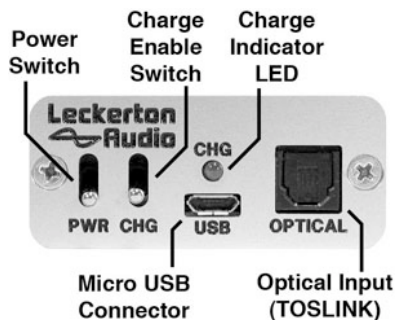

1. **Power Switch** – Enables power to the amplifier. In the *up* position, the amplifier is powered on.
2. **Charge Enable Switch** – In the *up* position, USB charging is enabled. In the *down* position, USB charging is disabled and the battery is used to power the amplifier. Disable USB charging to maximize portable computer battery life.
3. **Micro USB Connector** – Connect to a computer using a micro USB cable. Compatible with USB 1.1 and USB

2.0 connections.

4. **Optical Input (TOSLINK)** – Connect to a digital audio source using a TOSLINK cable. Maximum supported word length and sample rate is 24-bit/96kHz.
5. **Charge Indicator LED** – This LED is orange during charging. Charging stops automatically when the battery is fully charged.

### USB Streaming Configuration

The UHA-6S uses the default USB audio drivers which are included with Windows and Mac OS. In most cases, the UHA-6S is automatically selected as the output sound device after connection to the computer. In some cases it is required to manually select the UHA-6S as the output device:

In Windows XP, double-click the **Sounds and Audio Devices** icon in the Control Panel. On the **Audio** tab, under the **Sound playback** tab, select *USB Audio DAC*.

In Windows Vista and Windows 7, double-click the **Sound** icon in the Control Panel. On the **Playback** tab, select *USB Audio DAC*.

In Mac OS 10.0 or later, select **Sound** in System Preferences. On the **Output** tab, select *USB Audio DAC*.

*Note:* Audio playback should be stopped before disconnecting the UHA-6S from USB.

Compatible operating systems are Microsoft Windows 98SE, 98ME, 2000, XP, Vista, Mac OS 9.1 or later, and Mac OS 10.0 or later.

### Battery Charging

The battery is charged via the USB connection. To enable USB charging, set the charge enable switch to the *up* position. The charge indicator LED turns orange while charging. Charging is complete when the CHG indicator LED turns off. Charging starts and stops automatically. The UHA-6S takes approximately 6 hours to charge from a fully depleted battery. Charge time is longer if the amplifier is powered on while charging.

### Battery Replacement

Under normal usage, the Lithium-ion battery in the UHA-6S should never need replacement. However, if you notice that the battery begins to lose its ability to maintain a full charge, you can purchase a replacement battery from Leckerton Audio. For information on battery replacement, email [customer\\_service@leckertonaudio.com](mailto:customer_service@leckertonaudio.com).

**WARNING:** Use of non-supported batteries can result in damage and injury.

### Full 2-Year Warranty

The UHA-6S comes with a 2-Year Warranty which covers the cost of repairs (parts and labor) within the first two years after original purchase date (transferable to a new owner). If Leckerton Audio is unable to repair your amplifier, a replacement will be provided. The warranty does not cover damage caused by misuse, neglect, abuse, or failure to follow the operating instructions. The owner is responsible for the cost of shipping the amplifier to Leckerton Audio for repair service. For information on obtaining warranty or repair service, send an email to [repairs@leckertonaudio.com](mailto:repairs@leckertonaudio.com).

## Op-amp Replacement

The UHA-6S has replaceable output op-amps and DAC filter op-amps. Please exercise caution during disassembly. When exposed to the environment, the circuitry can be damaged by electrostatic discharge (static shock). It is highly advisable to wear a grounding wrist strap while performing the following steps.

**Note:** The owner assumes responsibility for any damage caused while replacing the op-amps. Warranty coverage for any such damage is at the discretion of Leckerton Audio.

**Warning:** The Lithium-ion battery can be hazardous if mishandled. Do not puncture, expose to high temperature, or short the battery contacts.

**Step 1:** Remove the two screws on the front panel. The back panel does not need to be removed.

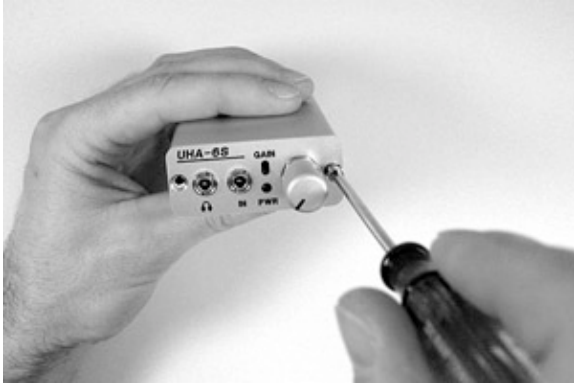

**Step 2:** Grasp the front panel and slide the circuit board assembly out of the aluminum case.

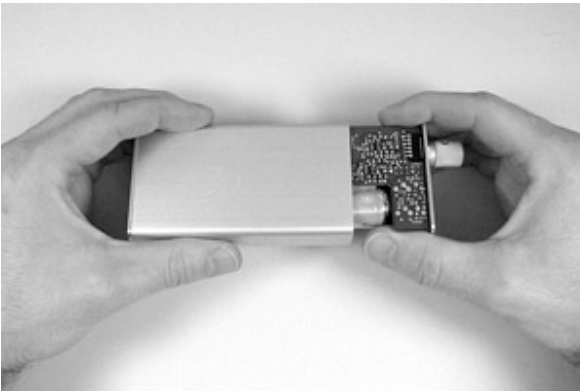

**Step 3:** Gently loosen the battery from its slot. The battery does not need to be disconnected from the circuit board.

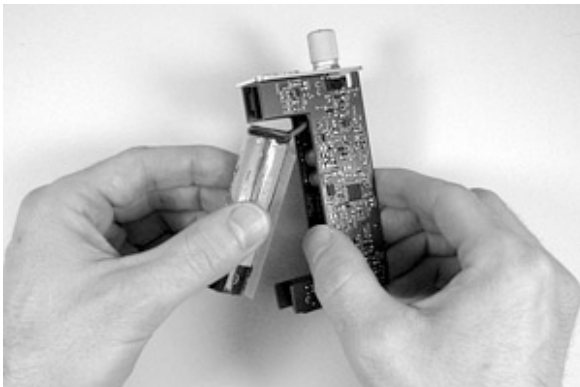

**Step 4:** Disconnect the two circuit boards. First pull the two boards apart at the connector, which is located near the end with the power switch. Use a slight side-to-side rocking motion if the connection is tight. When the connector is loose, the interface board (the right-hand board in the photo below) will slide freely from the front panel.

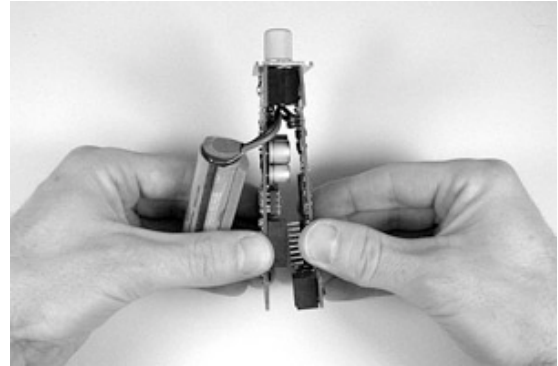

**Step 5:** The op-amps are now accessible on the audio board (the right-hand board in the photo below). Use a DIP extraction tool to remove the op-amps from the DIP sockets.

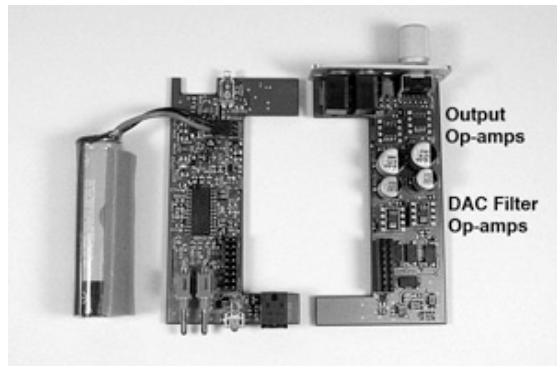

To assemble the UHA-6S, simply follow the above steps in reverse order.

## Technical Specifications

- Op-amp supply rails: +/-6 VDC
- Max output power (typical):
  - 25 mW into 16 ohms
  - 50 mW into 32 ohms
  - 75 mW into 100 ohms
  - 35 mW into 300 ohms
- THD+N at 1 kHz (20 Hz to 80 kHz bandwidth, no weighting):
  - 0.006%, 1 mW into 16 ohms
  - 0.005%, 1 mW into 32 ohms
  - 0.004%, 1 mW into 100 ohms
  - 0.003%, 1 mW into 300 ohms
- Dynamic range, A-weighted (typical):
  - 96 dB, USB input
  - 110 dB, optical input
  - >120 dB, analog input
- Gain: +6dB/+18dB
- 14 dBu max into high-impedance load (>600 ohms)
- Frequency response: 3 Hz to 23 kHz, +0/-1 dB (48 kHz sampling rate)
- Battery life: 30 hrs typical (analog), 12 hrs typical (optical)
- USB current draw: 500 mA maximum
- USB sample rates supported: 32/44.1/48 kHz (16-bit)
- Optical (TOSLINK) sample rates supported: 24-bit/96kHz
- Enclosure: extruded aluminum, anodized
- Dimensions: 4.0" x 2.1" x 0.9"